

**Lemi**<sup>®</sup>  
ITALIAN WELLNESS EQUIPMENT



# CLASSIC



FAVORITE  
TREATMENT TABLE MANUFACTURER

*All the treatment tables of the CLASSIC line feature the traditional mattress with horseshoe headrest, and are suitable for body massages and facial treatments. All are electrically adjustable (height, back, leg) and allow the relax position.*

Tutti i lettini della linea CLASSIC presentano il tradizionale materasso con testa a ferro di cavallo, e risultano ideali per massaggi corpo, trattamenti viso. Tutti sono regolabili elettricamente (altezza schiena gamba) e permettono la posizione relax.

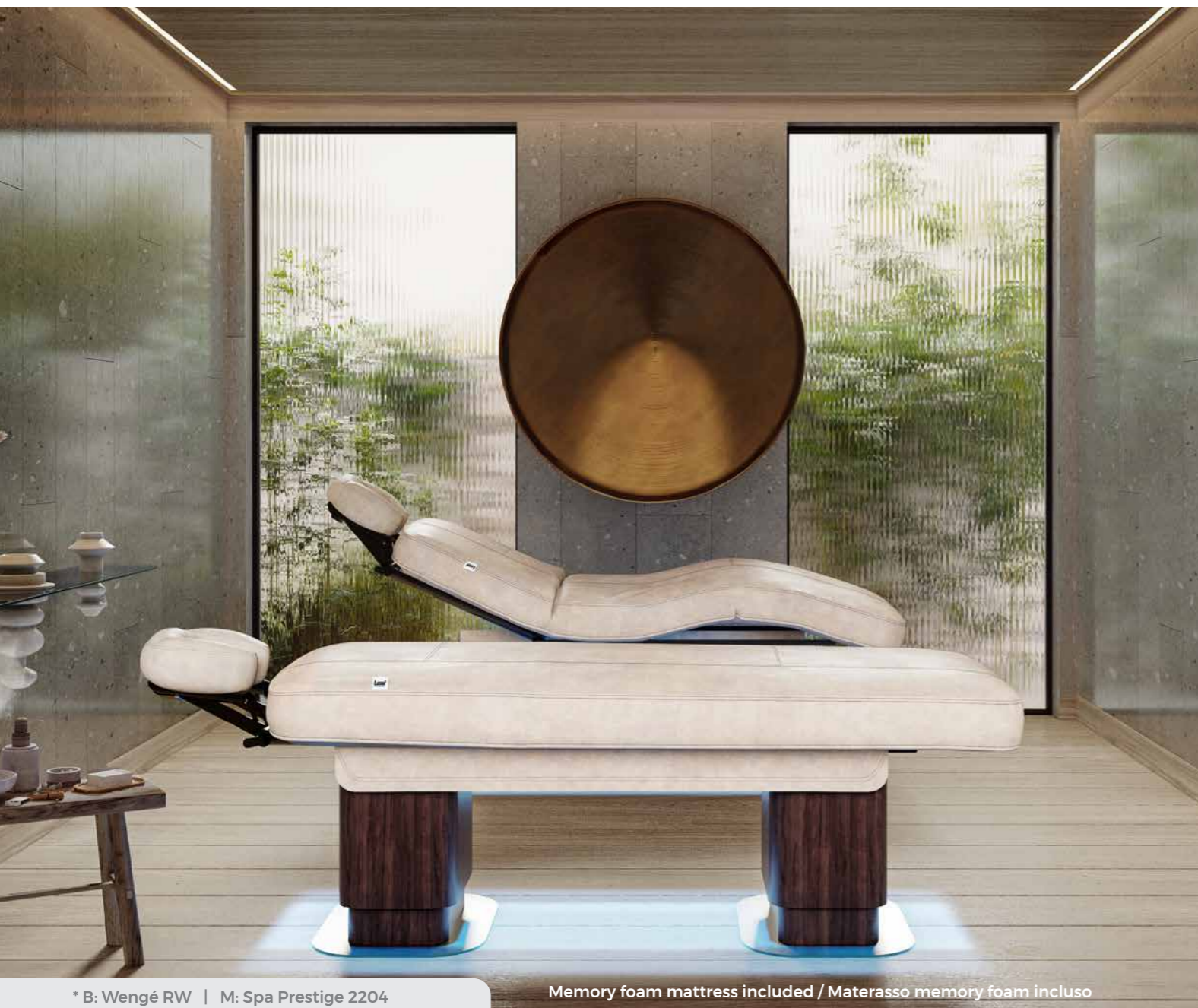

\* B: Wengé RW | M: Spa Prestige 2204

Memory foam mattress included / Materasso memory foam incluso

## COD. 1330

Imagine offering a spa experience that perfectly combines technology, design, and sustainability: MILANO, the spa bed that redefines luxury. Not just a work tool, but a true work of art thanks to the Memory Foam mattress with a horseshoe-shaped head and a structure made of curved wood and painted steel that reflects Italian craftsmanship. When paired with the chromotherapy of the two LED strips that illuminate the environment, a unique atmosphere is created for every wellness experience. Beyond aesthetics and comfort, Milano is a commitment to sustainability, with FSC certified materials; it's customization, with a range of exclusive finishes and materials; it's the ultimate wellness experience, designed for those who seek only the best.

IDEAL FOR: massages, face and body treatments, hair removal, treatments with aesthetic equipment.

Immaginate di offrire un'esperienza spa che coniughi perfettamente tecnologia, design e sostenibilità: MILANO, il lettino spa che ridefinisce il lusso. Non solo uno strumento di lavoro, ma una vera opera d'arte grazie al materasso in Memory Foam con testa a ferro di cavallo ed una struttura in legno curvato e acciaio verniciato che rispecchia l'artigianato italiano. Se abbinato alla cromoterapia delle due strisce LED che illuminano l'ambiente, si crea un'atmosfera unica per ogni esperienza di benessere. Oltre ad estetica e comfort, Milano è impegno per la sostenibilità, con materiali certificati FSC; è personalizzazione, con una gamma di finiture e materiali esclusivi; è esperienza di benessere definitiva, pensata per chi cerca solo il meglio.

IDEALE PER: massaggi, trattamenti viso e corpo, depilazione, trattamenti con apparecchiature estetiche.

\* The images are for illustrative purposes only and may not reflect the actual image of the finishing.

\* Le immagini hanno valore puramente illustrativo e possono non rispecchiare l'immagine reale della finitura.

## Focus on

- 3 electric motors for height, backrest and legrest adjustment
  - Standard handset control with 2 options for MEMORY function
  - AUT function: automatic return from any position to zero position (flat and minimum height)
  - END function: "End of treatment" position
  - Double column in curved wood and base in painted steel
  - Standard memory foam mattress with horseshoe headrest
  - Fire resistant "Azo" free, anti-bacterial and anti-fungal covering
  - Multifunctional solution, maximum customer / operator comfort
- 3 motori elettrici per regolazione di altezza, schienale e poggiatesta
  - Pulsantiera standard con 2 opzioni di funzione MEMORIE
  - Funzione AUT: ritorno automatico da ogni posizione alla posizione zero (piatto e altezza minima)
  - Funzione END: posizione "fine del trattamento"
  - Doppia colonna in legno curvato e base in acciaio verniciato
  - Materasso standard con memory foam e testa a ferro di cavallo
  - Rivestimento ignifugo, "Azo" free, antibatterico, antimicotico
  - Soluzione multifunzionale, massimo comfort cliente / operatore

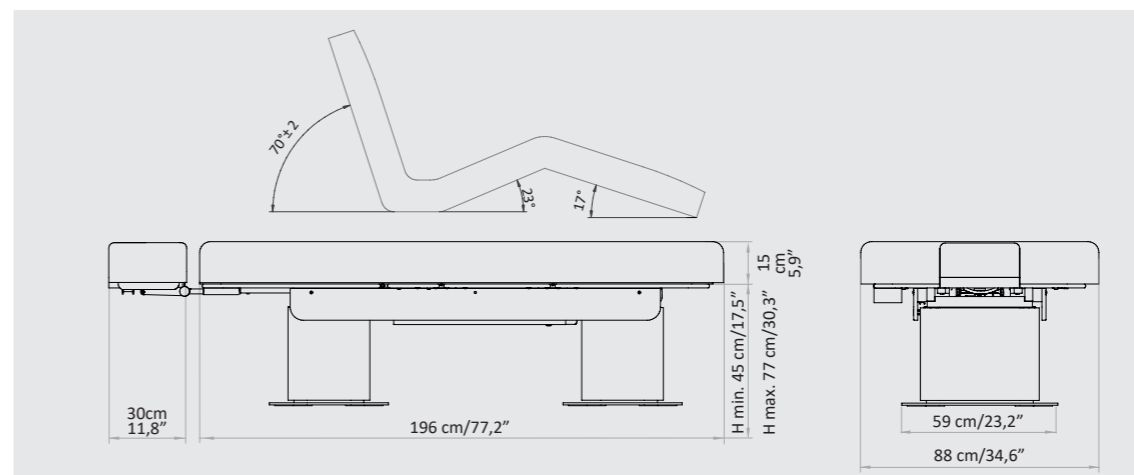

## Packaging details

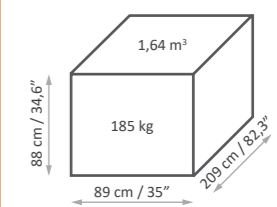

MAXIMUM CAPACITY  
PORTATA MASSIMA  
**200 kg**

# MATTRESS CUSTOMIZATION PERSONALIZZAZIONE MATERASSO

## VITA - COLOR CHART



EV00021



EV00022



EV00041



EV00042

## SPA PRESTIGE - COLOR CHART



9916



1424

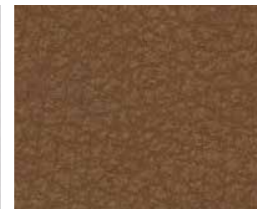

1423



1422

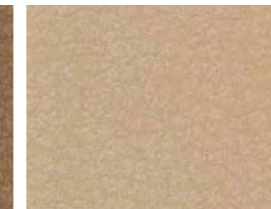

2202



2204



7022



7023



1875



1530

## NEFOS - COLOR CHART



6



1957



6985



3962



1155



2124



1194



2173



6986



569



667



680



64



71



1868



1843



8019



8009



5946



6940



6941



6942



1388

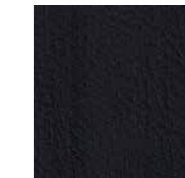

991

The innovative VITA (consisting of 80% natural and renewable components), Spa Prestige and Nefos materials - which are exclusive for LEMI products - and their special finishing touch guarantee easy-cleaning and hygiene. Their extraordinary structural qualities will persist through the years. An incredibly elastic texture enhances the memory foam mattress softness and quality at its best, giving Spa Clients a complete and satisfying wellness experience.

Gli innovativi materiali VITA (costituiti per l'80% da componenti naturali e rinnovabili), Spa Prestige e Nefos - che sono un'esclusiva dei prodotti LEMI - ed il loro speciale tocco di finitura garantiscono una facile pulizia e igiene. Le loro straordinarie qualità strutturali permangono nel corso degli anni. Una texture incredibilmente elastica migliora al massimo la morbidezza e la qualità del materasso in Memory Foam, dando ai clienti Spa un'esperienza di benessere completa e soddisfacente.

The images are for illustrative purposes only and may not reflect the actual finish of the product, particularly when viewed through a screen. Therefore, the **SELECTION OF THE FINISHES** of the **BASES** and **MATTRESS FABRICS** must take place **AFTER CONSULTING** the **LUXURY BOX PHYSICAL SAMPLES** and the **COLOR CHARTS**.

Le immagini hanno valore puramente illustrativo e possono non rispecchiare la finitura reale del prodotto, in particolare se visualizzate attraverso uno schermo. Pertanto la **SELEZIONE DELLE FINITURE** delle **BASI** e dei **RIVESTIMENTI** dei **MATERASSI** deve avvenire **PREVIA CONSULTAZIONE** della **CAMPIONATURA FISICA** della **LUXURY BOX** e delle **CARTELLE COLORI**.

# BASE CUSTOMIZATION PERSONALIZZAZIONE BASE

## SIRIO - FINISHES CHART



Today, 70% of the company's wooden equipment and treatment tables are manufactured using FSC certified lumber from unprotected forests. The woods are furnished by suppliers that have committed themselves to sustainable development, guaranteeing full compliance with the best environmental protection practices.









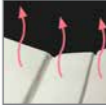

Oggi, il 70% delle attrezzature e dei lettini in legno dell'azienda sono realizzati con legname certificato FSC proveniente da foreste non protette. I legni provengono da fornitori che si sono impegnati per lo sviluppo sostenibile, garantendo il pieno rispetto delle migliori pratiche di tutela ambientale.

The images are for illustrative purposes only and may not reflect the actual finish of the product, particularly when viewed through a screen. Therefore, the **SELECTION OF THE FINISHES** of the **BASES** and **MATTRESS FABRICS** must take place **AFTER CONSULTING** the **LUXURY BOX PHYSICAL SAMPLES** and the **COLOR CHARTS**.

Le immagini hanno valore puramente illustrativo e possono non rispecchiare la finitura reale del prodotto, in particolare se visualizzate attraverso uno schermo. Pertanto la **SELEZIONE DELLE FINITURE** delle **BASI** e dei **RIVESTIMENTI** dei **MATERASSI** deve avvenire **PREVIA CONSULTAZIONE** della **CAMPIONATURA FISICA** della **LUXURY BOX** e delle **CARTELLE COLORI**.

# ACCESSORIES UPON REQUEST ACCESSORI SU RICHIESTA

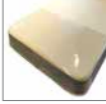
All tables have a standard setting customizable upon request.  
Tutti i lettini hanno una configurazione standard personalizzabile su richiesta.

- |   |  |   |  |
|---|--|---|--|
|    | <i>Arm support</i><br>Appoggiabraccia  |    | <i>Heating system</i><br>Riscaldamento   |
|    | <i>Mattress protection with polyurethane XL</i><br>Coprilettino XL in spugna con poliuretano |    | <i>UK cable</i><br>Cavo UK   |
|    | <i>Luxury towel</i><br>Telo Deluxe   |    | <i>USA cable</i><br>Cavo USA   |
|    | <i>Color therapy</i><br>Cromoterapia   |    | <i>Disposable cover for horseshoe headrest</i><br>(250 pcs./pack)<br>Copritesta monouso testa a ferro di cavallo<br>(confezione da 250 pz) |
|   | <i>Wireless foot pedal control with memories</i><br>Pedaliera wireless con memorie           |   | <i>Plastic leg protection</i><br>Protezione gambe in plastica  |
|  | <i>Cushion without face hole</i><br>Testa senza foro   |  | <i>Customized mattress with logo</i><br>Personalizzazione materasso con logo   |

# LEMI MATTRESSES STANDARD

Each mattress is HANDCRAFTED, therefore the ACTUAL MEASUREMENTS MAY VARY from those indicated in the catalogue by approximately  $\pm 1$  cm (also based on the selected configuration).



CLASSIC LINE - STANDARD

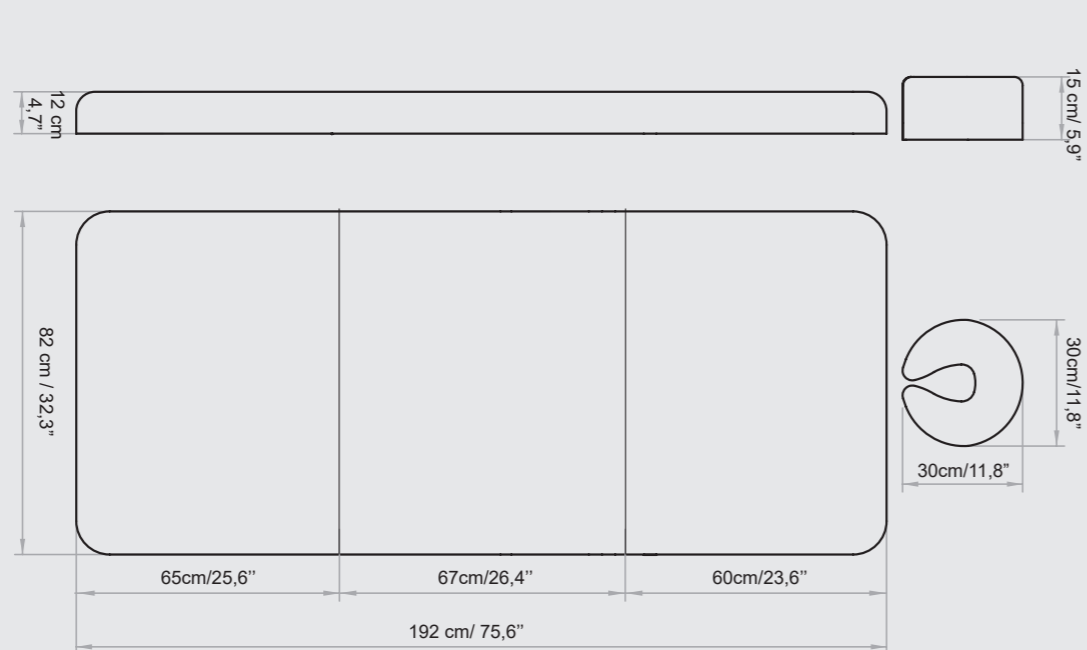

# MATERASSI LEMI MEMORY

Ogni materasso è realizzato A MANO, pertanto le MISURE REALI POTREBBERO VARIARE rispetto a quelle indicate nel catalogo di circa  $\pm 1$  cm (anche in base alla configurazione selezionata).

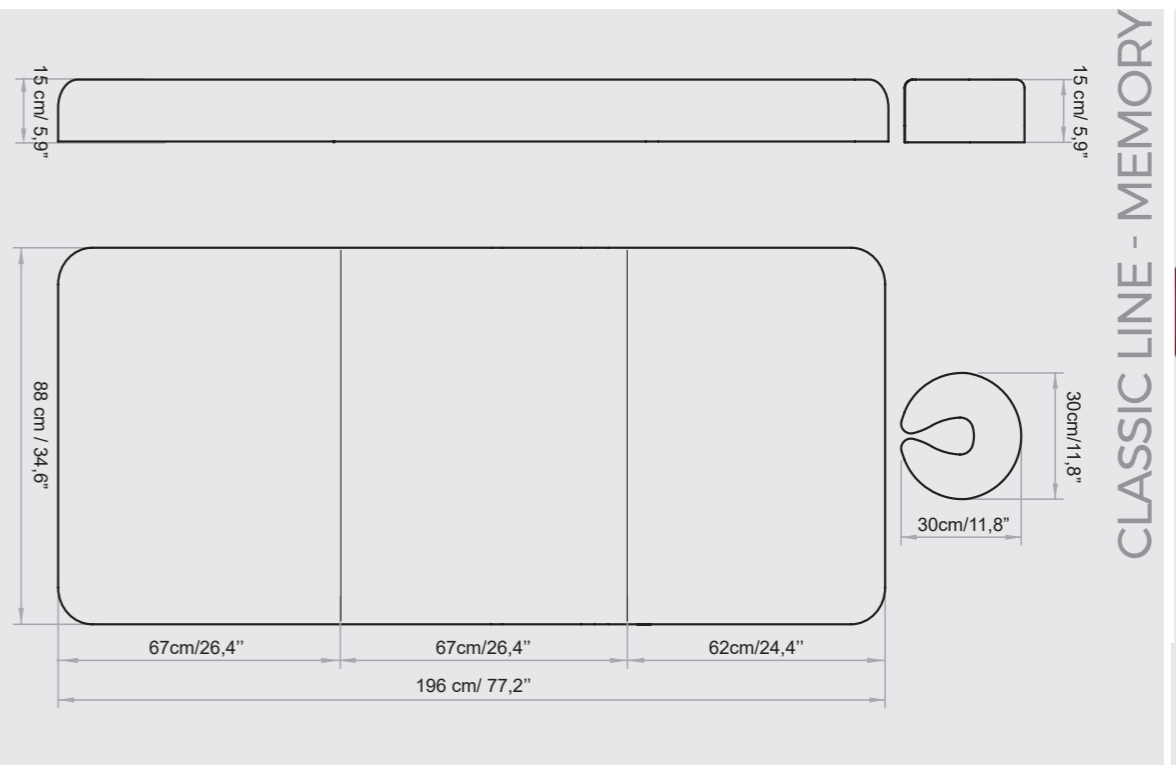

CLASSIC LINE - MEMORY

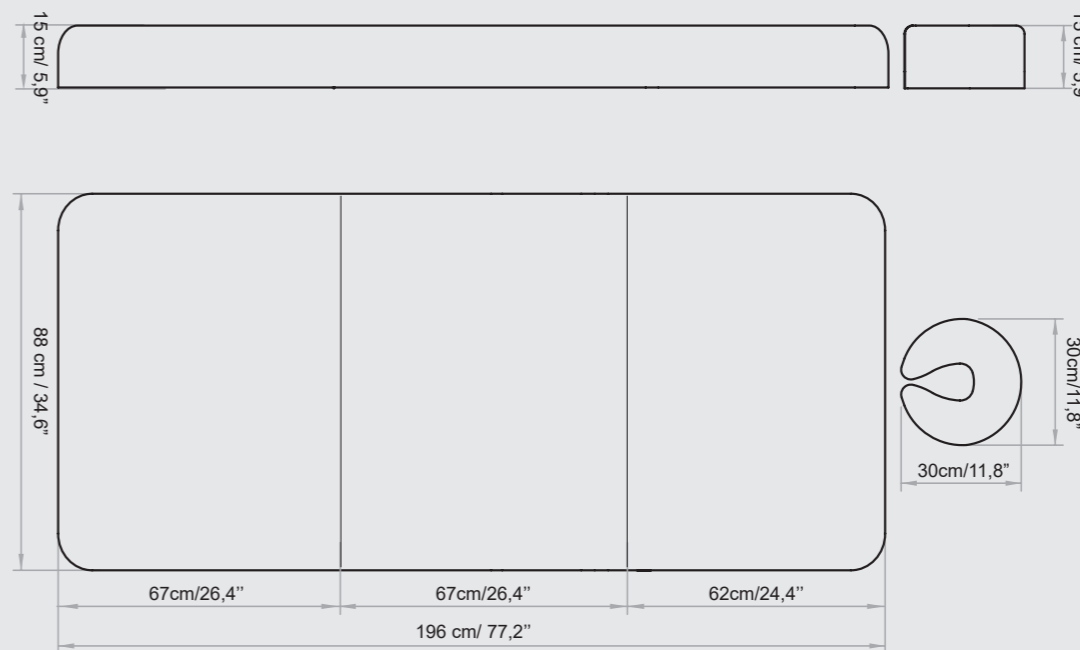

VERONA - STANDARD

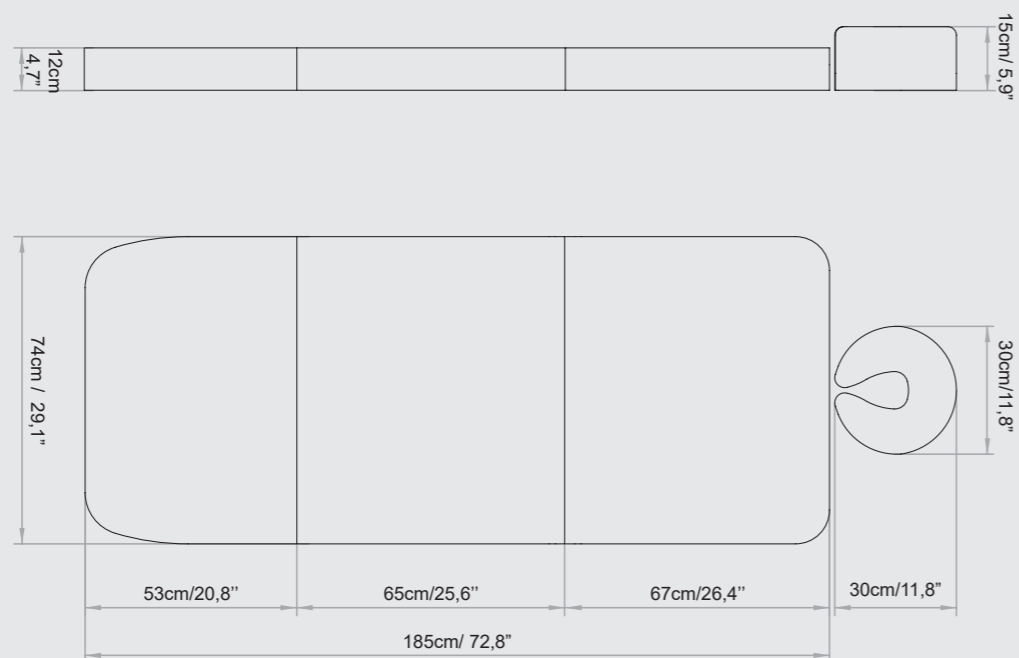

## MEMORY FOAM MATTRESS

### Super Soft Mattress in Memory Foam Thickness 15 cm

The Memory Foam mattress allows an optimal comfort for the patient even for long-lasting treatments. Furthermore, with the handset control supplied, the patient can independently adjust the chair to find the most comfortable position.

### Materasso Super Soft in Memory Foam Spessore 15 cm

Il materasso in Memory Foam permette un comfort ottimale del paziente anche per trattamenti di lunga durata. Inoltre con la pulsantiera in dotazione il paziente può regolare in autonomia la poltrona trovando la posizione più comoda.

# TECHNICAL REQUIREMENTS

## CARATTERISTICHE TECNICHE

ABSORPTION ASSORBIMENTO	VOLTAGE VOLTAGGIO	POWER POTENZA	FREQUENCY FREQUENZA	WARRANTY	GARANZIA
4 Amax (1,7 A)	100 Vac (240Vac)	250W	50/60 Hz	<i>Mattress heating: 1 year</i> <i>Electric parts and controls: 3 years</i> <i>Undeformable foam: 5 years</i> <i>Actuators: 5 years</i> <i>Structure: Lifetime</i>	Riscaldamento materasso: 1 anno Parti elettriche e comandi: 3 anni Gomma indeformabile: 5 anni Attuatori: 5 anni Struttura: a vita

### REGULATIONS

All Equipment is **CE** marked

#### Electrical equipment and beds

Directive 2006/42/CE (Machinery Directive) and national regulations

Directive 2014/30/UE (Electromagnetic Compatibility Directive) and national regulations.

#### Images

The images are for illustrative purposes only and may not reflect the actual image of the product.

### NORME

Tutte le attrezzature sono a marchio **CE**

#### Attrezzature e lettini elettrici

Direttiva 2006/42/CE (Direttiva Macchine) e disposizioni nazionali di attuazione

Direttiva 2014/30/UE (Direttiva Compatibilità elettromagnetica) e disposizioni nazionali di attuazione.

#### Immagini

Le immagini hanno valore puramente illustrativo e possono non rispecchiare l'immagine reale del prodotto.

**Lemi**<sup>®</sup>  
ITALIAN WELLNESS EQUIPMENT

#### Brusafferri & C srl

Via Mara Maretti Soldi, 13  
26011 Casalbuttano (CREMONA) ITALY  
Phone +39-0374-363069 Fax +39-0374-363071  
info@lemigroup.it service@lemigroup.it

www.lemigroup.it